

## 4M-WORD BY 64-BIT SYNCHRONOUS DYNAMIC RAM MODULE

### UNBUFFERED TYPE

#### Description

The MC-454CB645 is a 4,194,304 words by 64 bits synchronous dynamic RAM module on which 4 pieces of 64M

★ SDRAM :  $\mu$ PD4564163 are assembled.

This module provides high density and large quantities of memory in a small space without utilizing the surface-mounting technology on the printed circuit board.

Decoupling capacitors are mounted on power supply line for noise reduction.

#### Features

- 4,194,304 words by 64 bits organization
- Clock frequency and access time from CLK

Part number	/CAS latency	Clock frequency (MAX.)	Access time from CLK (MAX.)	Power consumption (MAX.)	
				Active	Standby
MC-454CB645FA-A10B	CL = 3	100 MHz	7 ns	2,376 mW	7.2 mW (CMOS level input)
	CL = 2	67 MHz	8 ns	1,584 mW	
★ MC-454CB645LFA-A10B	CL = 3	100 MHz	7 ns	2,376 mW	
	CL = 2	67 MHz	8 ns	1,584 mW	

- Fully Synchronous Dynamic RAM, with all signals referenced to a positive clock edge
- Pulsed interface
- Possible to assert random column address in every cycle
- Quad internal banks controlled by BA0 and BA1 (Bank Select)
- Programmable burst-length : 1, 2, 4, 8 and full page
- Programmable wrap sequence (sequential / interleave)
- Programmable /CAS latency (2, 3)
- Automatic precharge and controlled precharge
- CBR (Auto) refresh and self refresh
- All DQs have  $10\ \Omega \pm 10\%$  of series resistor
- Single  $3.3\ \text{V} \pm 0.3\ \text{V}$  power supply
- LVTTTL compatible
- 4,096 refresh cycles / 64 ms
- Burst termination by Burst Stop command and Precharge command
- 168-pin dual in-line memory module (Pin pitch = 1.27 mm)
- Unbuffered type
- Serial PD

The information in this document is subject to change without notice.

**Ordering Information**

Part number	Clock frequency (MAX.)	Package	Mounted devices
MC-454CB645FA-A10B	100 MHz	168-pin Dual In-line Memory Module (Socket Type) Edge connector : Gold plated	4 pieces of $\mu$ PD4564163G5 (Rev. E) (400mil TSOP (II))
★ MC-454CB645LFA-A10B	100 MHz	29.21 mm (1.15 inch) height	4 pieces of $\mu$ PD4564163G5 (Rev. L) (400mil TSOP (II))

Pin Configuration

168-pin Dual In-line Memory Module Socket Type (Edge connector: Gold plated)

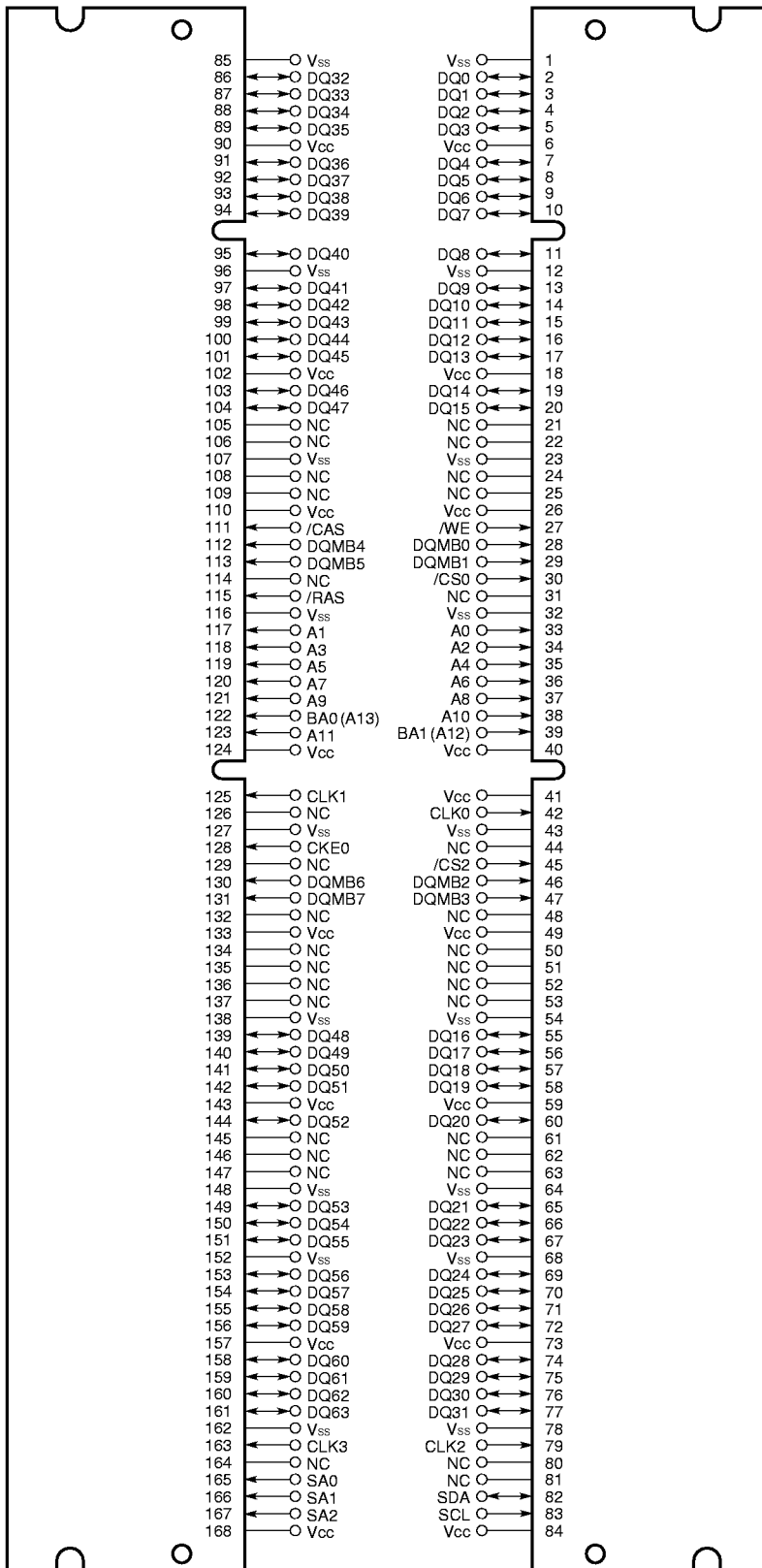

/xxx indicates active low signal.

- A0 - A11 : Address Inputs  
[Row : A0 - A11, Column : A0 - A7]
- BA0 (A13),  
BA1 (A12) : SDRAM Bank Select
- DQ0 - DQ63 : Data Inputs / Outputs
- CLK0 - CLK3 : Clock Input
- CKE0 : Clock Enable Input
- /CS0, /CS2 : Chip Select Input
- /RAS : Row Address Strobe
- /CAS : Column Address Strobe
- /WE : Write Enable
- DQMB0 - DQMB7 : DQ Mask Enable
- SA0 - SA2 : Address Input for EEPROM
- SDA : Serial Data I/O for PD
- SCL : Clock Input for PD
- Vcc : Power Supply
- Vss : Ground
- NC : No Connection

Block Diagram

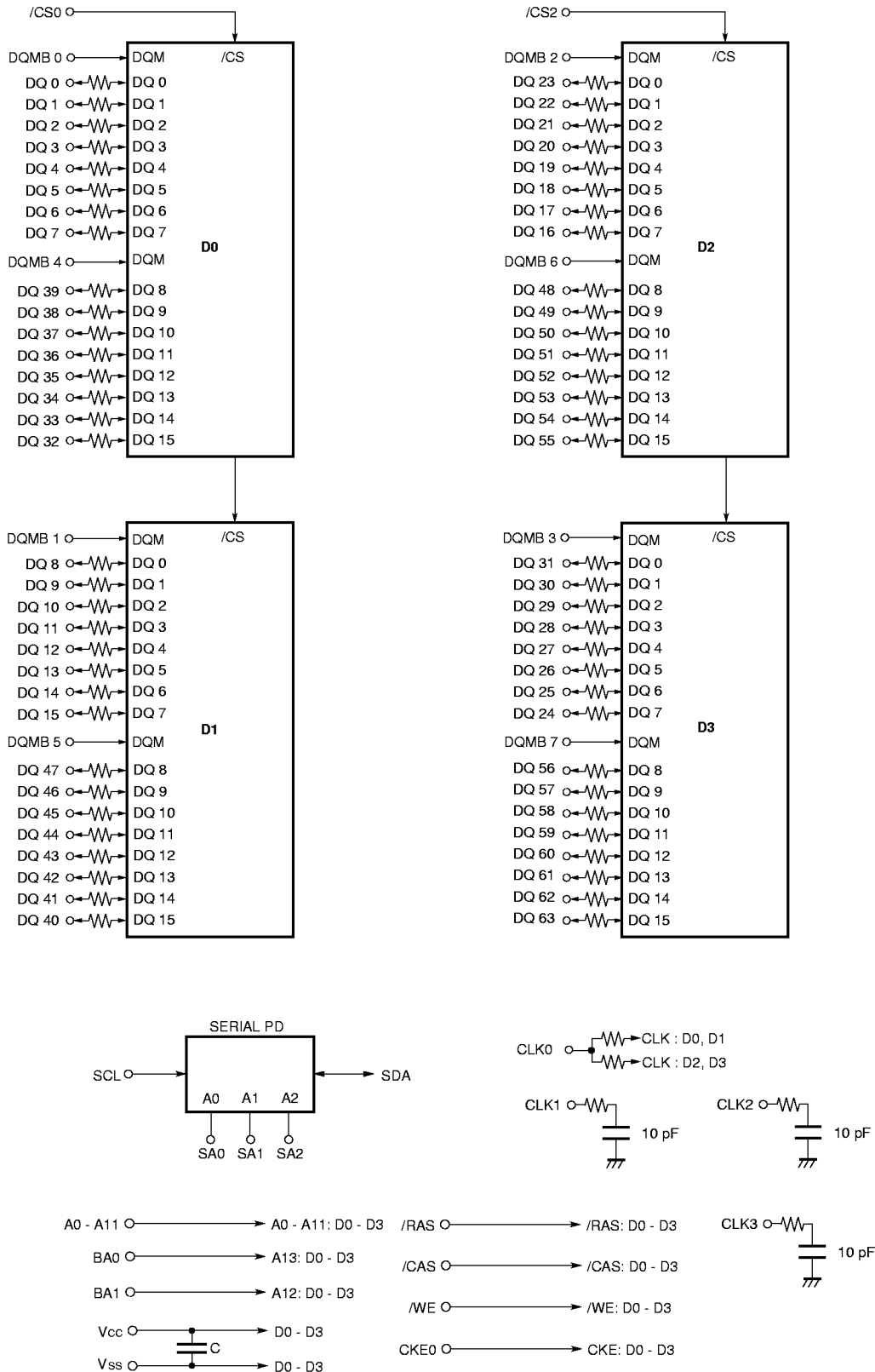

- Remarks**
1. The value of all resistors is 10  $\Omega$ .
  2. D0 - D3 :  $\mu$ tPD4564163 (1M words  $\times$  16 bits  $\times$  4 banks)

★

**Electrical Specifications**

- All voltages are referenced to V<sub>SS</sub> (GND).
- ★ • After power up, wait more than 100  $\mu$ s and then, execute power on sequence and CBR (Auto) refresh before proper device operation is achieved.

**Absolute Maximum Ratings**

Parameter	Symbol	Condition	Rating	Unit
Voltage on power supply pin relative to GND	V <sub>CC</sub>		-0.5 to +4.6	V
Voltage on input pin relative to GND	V <sub>T</sub>		-0.5 to +4.6	V
Short circuit output current	I <sub>O</sub>		50	mA
Power dissipation	P <sub>D</sub>		4	W
Operating ambient temperature	T <sub>A</sub>		0 to +70	°C
Storage temperature	T <sub>stg</sub>		-55 to +125	°C

**Caution** Exposing the device to stress above those listed in Absolute Maximum Ratings could cause permanent damage. The device is not meant to be operated under conditions outside the limits described in the operational section of this specification. Exposure to Absolute Maximum Rating conditions for extended periods may affect device reliability.

**Recommended Operating Conditions**

Parameter	Symbol	Condition	MIN.	TYP.	MAX.	Unit
Supply voltage	V <sub>CC</sub>		3.0	3.3	3.6	V
High level input voltage	V <sub>IH</sub>		2.0		V <sub>CC</sub> + 0.3	V
Low level input voltage	V <sub>IL</sub>		-0.3		+0.8	V
Operating ambient temperature	T <sub>A</sub>		0		70	°C

**Capacitance (T<sub>A</sub> = 25 °C, f = 1 MHz)**

Parameter	Symbol	Test condition	MIN.	TYP.	MAX.	Unit
Input capacitance	C <sub>I1</sub>	A0 - A11, BA0 (A13), BA1 (A12), /RAS, /CAS, /WE			41	pF
	C <sub>I2</sub>	CLK0			38	
	C <sub>I3</sub>	CKE0			34	
	C <sub>I4</sub>	/CS0, /CS2			24	
	C <sub>I5</sub>	DQMB0 - DQMB7			12	
Data input / output capacitance	C <sub>I/O</sub>	DQ0 - DQ63			13	pF

DC Characteristics (Recommended Operating Conditions Unless Otherwise Noted)

Parameter	Symbol	Test condition	MIN.	MAX.	Unit	Notes
Operating current	I <sub>CC1</sub>	Burst length = 1, t <sub>RC</sub> ≥ t <sub>RC(MIN.)</sub> , I <sub>O</sub> = 0 mA	/CAS latency = 2	280	mA	1
			/CAS latency = 3	360		
Precharge standby current in power down mode	I <sub>CC2P</sub>	CKE ≤ V <sub>IL(MAX.)</sub> , t <sub>CK</sub> = 15 ns		4	mA	
	I <sub>CC2PS</sub>	CKE ≤ V <sub>IL(MAX.)</sub> , t <sub>CK</sub> = ∞		2		
Precharge standby current in non power down mode	I <sub>CC2N</sub>	CKE ≥ V <sub>IH(MIN.)</sub> , t <sub>CK</sub> = 15 ns, /CS ≥ V <sub>IH(MIN.)</sub> , Input signals are changed one time during 30 ns.		80	mA	
	I <sub>CC2NS</sub>	CKE ≥ V <sub>IH(MIN.)</sub> , t <sub>CK</sub> = ∞, Input signals are stable.		24		
Active standby current in power down mode	I <sub>CC3P</sub>	CKE ≤ V <sub>IL(MAX.)</sub> , t <sub>CK</sub> = 15 ns		20	mA	
	I <sub>CC3PS</sub>	CKE ≤ V <sub>IL(MAX.)</sub> , t <sub>CK</sub> = ∞		16		
Active standby current in non power down mode	I <sub>CC3N</sub>	CKE ≥ V <sub>IH(MIN.)</sub> , t <sub>CK</sub> = 15 ns, /CS ≥ V <sub>IH(MIN.)</sub> , Input signals are changed one time during 30 ns.		100	mA	
	I <sub>CC3NS</sub>	CKE ≥ V <sub>IH(MIN.)</sub> , t <sub>CK</sub> = ∞, Input signals are stable.		40		
Operating current (Burst mode)	I <sub>CC4</sub>	t <sub>CK</sub> ≥ t <sub>CK(MIN.)</sub> , I <sub>O</sub> = 0 mA	/CAS latency = 2	440	mA	2
			/CAS latency = 3	660		
CBR (Auto) refresh current	I <sub>CC5</sub>	t <sub>RC</sub> ≥ t <sub>RC(MIN.)</sub>	/CAS latency = 2	420	mA	3
			/CAS latency = 3	460		
Self refresh current	I <sub>CC6</sub>	CKE ≤ 0.2 V		4	mA	
Input leakage current	I <sub>I(L)</sub>	V <sub>I</sub> = 0 to 3.6 V, All other pins not under test = 0 V	-4	+4	μA	
Output leakage current	I <sub>O(L)</sub>	D <sub>OUT</sub> is disabled, V <sub>O</sub> = 0 to 3.6 V	-1.5	+1.5	μA	
High level output voltage	V <sub>OH</sub>	I <sub>O</sub> = -4.0 mA	2.4		V	
Low level output voltage	V <sub>OL</sub>	I <sub>O</sub> = +4.0 mA		0.4	V	

- Notes**
- I<sub>CC1</sub> depends on output loading and cycle rates. Specified values are obtained with the output open. In addition to this, I<sub>CC1</sub> is measured on condition that addresses are changed only one time during t<sub>CK(MIN.)</sub>.
  - I<sub>CC4</sub> depends on output loading and cycle rates. Specified values are obtained with the output open. In addition to this, I<sub>CC4</sub> is measured on condition that addresses are changed only one time during t<sub>CK(MIN.)</sub>.
  - I<sub>CC5</sub> is measured on condition that addresses are changed only one time during t<sub>CK(MIN.)</sub>.

**AC Characteristics (Recommended Operating Conditions Unless Otherwise Noted)**

**AC Characteristics Test Conditions**

- AC measurements assume  $t_r = 1$  ns.
- Reference level for measuring timing of input signals is 1.4 V. Transition times are measured between  $V_{IH}$  and  $V_{IL}$ .
- If  $t_r$  is longer than 1 ns, reference level for measuring timing of input signals is  $V_{IH(MIN.)}$  and  $V_{IL(MAX.)}$ .
- An access time is measured at 1.4 V.

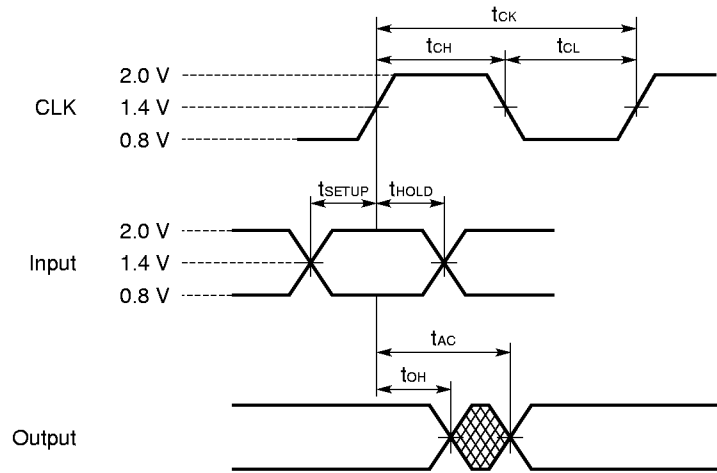

Synchronous Characteristics

Parameter		Symbol	-A 10B		Unit	Note
			MIN.	MAX.		
Clock cycle time	/CAS latency = 3	$t_{CK3}$	10	(100 MHz)	ns	
	/CAS latency = 2	$t_{CK2}$	15	(67 MHz)	ns	
Access time from CLK	/CAS latency = 3	$t_{AC3}$		7	ns	1
	/CAS latency = 2	$t_{AC2}$		8	ns	1
CLK high level width		$t_{CH}$	3.5		ns	
CLK low level width		$t_{CL}$	3.5		ns	
Data-out hold time		$t_{OH}$	3		ns	1
Data-out low-impedance time		$t_{LZ}$	0		ns	
Data-out high-impedance time	/CAS latency = 3	$t_{HZ3}$	3	7	ns	
	/CAS latency = 2	$t_{HZ2}$	3	8	ns	
Data-in setup time		$t_{DS}$	2.5		ns	
Data-in hold time		$t_{DH}$	1		ns	
Address setup time		$t_{AS}$	2.5		ns	
Address hold time		$t_{AH}$	1		ns	
CKE setup time		$t_{CKS}$	2.5		ns	
CKE hold time		$t_{CKH}$	1		ns	
CKE setup time (Power down exit)		$t_{CKSP}$	2.5		ns	
Command (/CS0, /CS2, /RAS, /CAS, /WE, DQMB0 - DQMB7) setup time		$t_{CMS}$	2.5		ns	
Command (/CS0, /CS2, /RAS, /CAS, /WE, DQMB0 - DQMB7) hold time		$t_{CMH}$	1		ns	

Note 1. Output load

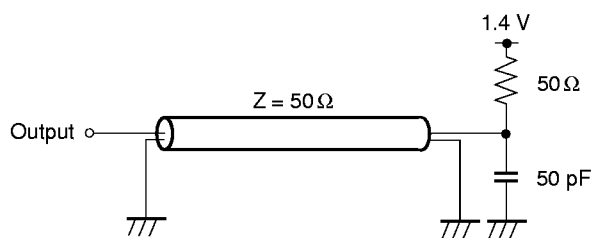

Remark These specifications are applied to the monolithic device.



Asynchronous Characteristics

Parameter	Symbol	-A 10B		Unit	Note
		MIN.	MAX.		
REF to REF/ACT command period	$t_{RC}$	90		ns	
ACT to PRE command period	$t_{RAS}$	60	120,000	ns	
PRE to ACT command period	$t_{RP}$	30		ns	
Delay time ACT to READ/WRITE command	$t_{RCD}$	30		ns	
ACT (0) to ACT (1) command period	$t_{RRD}$	20		ns	
Data-in to PRE command period	$t_{DPL}$	10		ns	
Data-in to ACT (REF) command period (Auto precharge)	/CAS latency = 3	$t_{DAL3}$	1 CLK + 30	ns	
	/CAS latency = 2	$t_{DAL2}$	1 CLK + 30	ns	
Mode register set cycle time	$t_{RSC}$	2		CLK	
Transition time	$t_T$	1	30	ns	
Refresh time (4,096 refresh cycles)	$t_{REF}$		64	ms	

Serial PD

(1/2)

Byte No.	Function Described	Hex	Bit 7	Bit 6	Bit 5	Bit 4	Bit 3	Bit 2	Bit 1	Bit 0	Notes
0	Defines the number of bytes written into serial PD memory	80H	1	0	0	0	0	0	0	0	128 bytes
1	Total number of bytes of serial PD memory	08H	0	0	0	0	1	0	0	0	256 bytes
2	Fundamental memory type	04H	0	0	0	0	0	1	0	0	SDRAM
3	Number of rows	0CH	0	0	0	0	1	1	0	0	12 rows
4	Number of columns	08H	0	0	0	0	1	0	0	0	8 columns
5	Number of banks	01H	0	0	0	0	0	0	0	1	1 bank
6	Data width	40H	0	1	0	0	0	0	0	0	64 bits
7	Data width (continued)	00H	0	0	0	0	0	0	0	0	0
8	Voltage interface	01H	0	0	0	0	0	0	0	1	LVTTTL
9	CL = 3 cycle time	A0H	1	0	1	0	0	0	0	0	10 ns
10	CL = 3 access time	70H	0	1	1	1	0	0	0	0	7 ns
11	DIMM configuration type	00H	0	0	0	0	0	0	0	0	None
12	Refresh rate / type	80H	1	0	0	0	0	0	0	0	Normal
13	SDRAM width	10H	0	0	0	1	0	0	0	0	x16
14	Error checking SDRAM width	00H	0	0	0	0	0	0	0	0	None
15	Minimum clock delay	01H	0	0	0	0	0	0	0	1	1 clock
16	Burst length supported	8FH	1	0	0	0	1	1	1	1	1, 2, 4, 8, F
17	Number of banks on each SDRAM	04H	0	0	0	0	0	1	0	0	4 banks
18	/CAS latency supported	06H	0	0	0	0	0	1	1	0	2, 3
19	/CS latency supported	01H	0	0	0	0	0	0	0	1	0
20	/WE latency supported	01H	0	0	0	0	0	0	0	1	0
21	SDRAM module attributes	00H	0	0	0	0	0	0	0	0	
22	SDRAM device attributes : General	0EH	0	0	0	0	1	1	1	0	
23	CL = 2 cycle time	F0H	1	1	1	1	0	0	0	0	15 ns
24	CL = 2 access time	80H	1	0	0	0	0	0	0	0	8 ns
25-26		00H	0	0	0	0	0	0	0	0	
27	t <sub>RP</sub> (MIN.)	1EH	0	0	0	1	1	1	1	0	30 ns
28	t <sub>RRD</sub> (MIN.)	14H	0	0	0	1	0	1	0	0	20 ns
29	t <sub>RCD</sub> (MIN.)	1EH	0	0	0	1	1	1	1	0	30 ns
30	t <sub>RAS</sub> (MIN.)	3CH	0	0	1	1	1	1	0	0	60 ns
31	Module bank density	08H	0	0	0	0	1	0	0	0	32M bytes

(2/2)

Byte No.	Function Described	Hex	Bit 7	Bit 6	Bit 5	Bit 4	Bit 3	Bit 2	Bit 1	Bit 0	Notes
32-61		00H	0	0	0	0	0	0	0	0	
62	SPD revision	01H	0	0	0	0	0	0	0	1	1
63	Checksum for bytes 0 - 62	31H	0	0	1	1	0	0	0	1	
64-71	Manufacture's JEDEC ID code										
72	Manufacturing location										
73-90	Manufacture's P/N										
91-92	Revision code										
93-94	Manufacturing date										
95-98	Assembly serial number										
99-125	Mfg specific										
126	Intel specification frequency	66H	0	1	1	0	0	1	1	0	66 MHz
127	Intel specification /CAS latency support	06H	0	0	0	0	0	1	1	0	2, 3

**Timing Chart**

Refer to the **SYNCHRONOUS DRAM MODULE TIMING CHART Information (M13348X)**.

Package Drawings

★ [MC-454CB645FA, MC-454CB645LFA]

168 PIN DUAL IN-LINE MODULE (SOCKET TYPE)

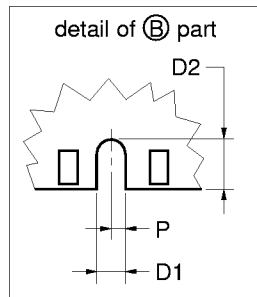
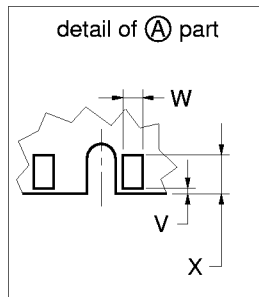
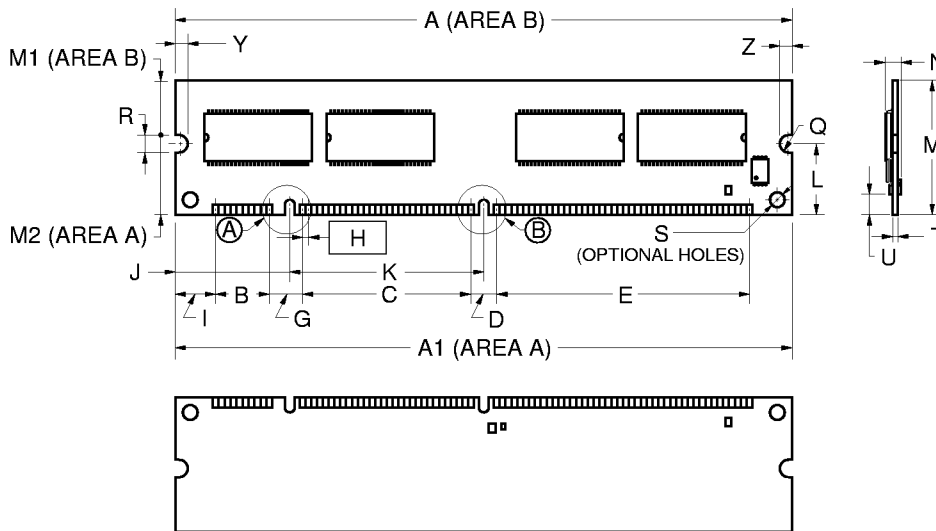

ITEM	MILLIMETERS	INCHES
A	133.35	5.250
A1	133.35±0.13	5.250±0.006
B	11.43	0.450
C	36.83	1.450
D	6.35	0.250
D1	2.0	0.079
D2	3.125	0.123
E	54.61	2.150
G	6.35	0.250
H	1.27 (T.P.)	0.050 (T.P.)
I	8.89	0.350
J	24.495	0.964
K	42.18	1.661
L	17.78	0.700
M	29.21±0.13	1.150±0.006
M1	9.43	0.371
M2	19.78	0.779
N	4.00 MAX.	0.158 MAX.
P	1.0	0.039
Q	R 2.0	R 0.079
R	4.00±0.10	0.157 <sup>+0.005</sup> <sub>-0.004</sub>
S	φ 3.0	φ 0.118
T	1.27±0.1	0.050±0.004
U	4.00 MIN.	0.157 MIN.
V	0.25 MAX.	0.010 MAX.
W	1.0±0.05	0.039 <sup>+0.003</sup> <sub>-0.002</sub>
X	2.54±0.10	0.100±0.004
Y	3.0 MIN.	0.118 MIN.
Z	3.0 MIN.	0.118 MIN.

M168S-50A88